

Tuyaux Articulés 1/2" - Ø 12,7

ROSAGE



GROS DÉBIT
Ø 12,7 mm
1/2"

Équipement 1/2"

Équipement standard

Longueur : 330 mm



50-813

12 segments
 wØ 6,35 - 9,5 - 12,7 mm
 2 raccords mâles : 1 en 1/2" et 1 en 3/8" NPT

LOC-LINE 1/2" GROS DÉBIT

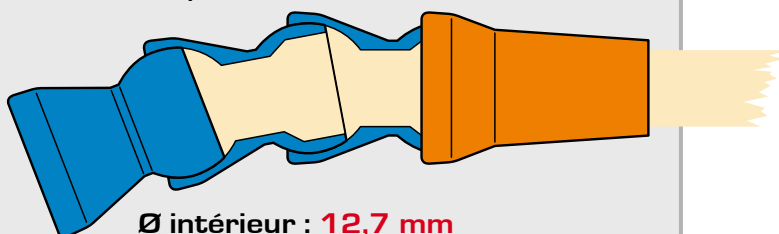

Ø intérieur : 12,7 mm

Pression maxi : 2 Bar

Débit : 30 litres / minute

Température d'utilisation maxi : 80°C

Raccords 3/8" et 1/2"

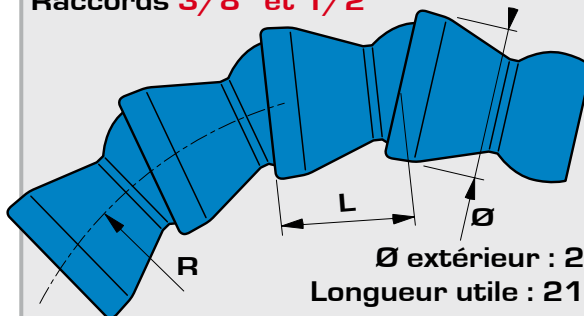

Ø extérieur : 24,9 mm

Longueur utile : 21,84 mm

Rayon de courbure mini : R 44 mm

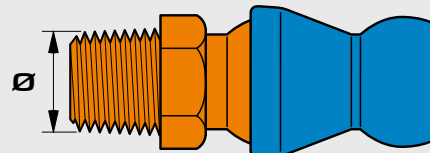

Filetages

NPT

BSP T

Filet à 60°

Filet à 55°

Ø - filets/pouce

Ø - filets/pouce

3/8"

17,3 mm

18

16,7 mm

19

1/2"

21 mm

14

21 mm

14

COMMENT UTILISER LOC-LINE AU MIEUX

Ligne bleue et orange "Acétal"

Oui	Acétone
Non	Acides
Oui	Alcool, éthyle
Non	Solution ammoniacale (forte)
Non	Bases (fortes)
Oui	Détergents commerciaux
Oui	Essence
Oui	Graisses
Non	Solutions d'ions hypochlorites
Oui	Solvants pour vernis
Oui	Huiles
Oui	Huiles solubles
Oui	Soude caustique
Non	Chlorate de sodium



LOC-LINE noir disponible sur commande



Tuyaux Articulés 1/2" - Ø 12,7

Segments rotules

Segment standard

265 mm, (12 pièces)

1 mètre, (46 pièces)

7,5 m, 1 bobine
(345 pièces)

15 m, 1 bobine (690 pièces)

Réf.



51-801

51-800

59-860

59-861

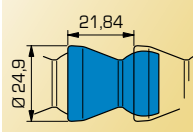

Segment long, 90 mm

Pochette de 4

Sachet de 20

Inclinaison :
28° maxi

Réf.



51-833

59-883

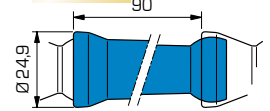

Anneau de rigidité

Pochette de 4

Sachet de 20

51-834

59-884

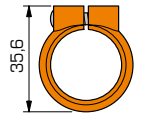

Assortiment

4 Segments longs, 4 Anneaux

51-835

nouveau
Segment coudé long
flexibilité, rigidité

Raccords filetés et Manchons taraudés

Raccord fileté

Réf.



3/8" NPT

Pochette de 4

Sachet de 50



51-804

59-864

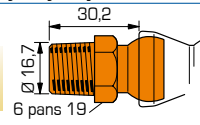

1/2" NPT

Pochette de 4

Sachet de 50



51-805

59-865

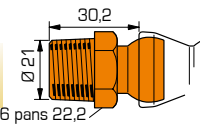

3/8" BSPT (Gaz)

Pochette de 4

Sachet de 50



51-826

59-876

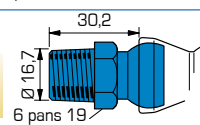

1/2" BSPT (Gaz)

Pochette de 4

Sachet de 50



51-827

59-877

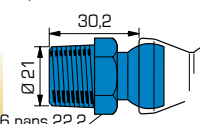

Manchon taraudé

3/8" NPT

vers 3/8" NPT

Pochette de 4



50-660

6 pans 21

1/2" NPT

vers 1/2" NPT

Pochette de 4



50-661

6 pans 26

Réducteur

3/8" - 1/4" NPT

Pochette de 4



50-658

6 pans 21

1/2" NPT

vers 1/4" NPT

Pochette de 4



50-659

6 pans 26

Robinet et Segments spéciaux

Robinet

1/2" NPT

mâle

Pochette de 2

Sachet de 10



Réf.



32-092

39-852

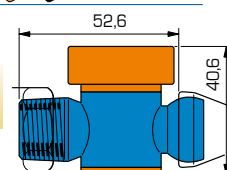

1/2" NPT

femelle

Pochette de 2

Sachet de 10



32-093

39-853

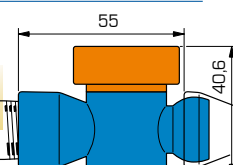

En ligne

Pochette de 2

Sachet de 10



32-094

39-854

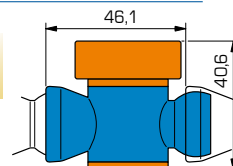

Métallique

3/8" BSPT

vers 3/8" BSPT

1 Robinet



50-310

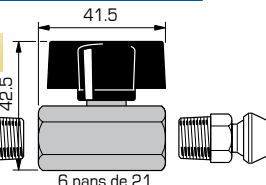

Valve anti-retour

Pochette de 2

Sachet de 10



Réf.



32-091

39-851

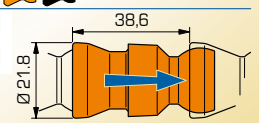

Stoppe l'écoulement de liquide lorsque la pompe est arrêtée. Le liquide est immédiatement disponible et réduit le fonctionnement à sec des outils. Débit minimum garanti : 95%

Segment à jet central

1 trou Ø 3,5 mm

Pochette de 4



Réf.



51-836

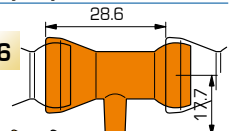

Bouchon obturateur

Pochette de 4



Réf.



51-838

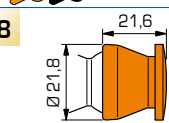

Cirque

Pochette comprenant :

15 Segments

1 Bouchon

Longueur : 620 mm

Ø mini inter : 114 mm

51-837



Tuyaux Articulés 1/2" - Ø 12,7

Buses rondes

Buse ronde

Réf. 

1 trou Ø 6,35 mm
Pochette de 4
Sachet de 50



51-806
59-866

1 trou Ø 9,5 mm
Pochette de 4
Sachet de 50



51-802
59-862

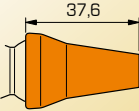

1 trou Ø 12,7 mm
Pochette de 4
Sachet de 50



51-803
59-863

Buse d'équerre

Réf. 

1 trou Ø 6,35 mm
Pochette de 4
Sachet de 20



51-828
59-878

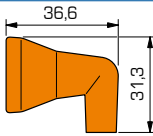

1 trou Ø 9,5 mm
Pochette de 4
Sachet de 20



51-829
59-879

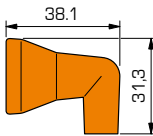

1 trou Ø 12,7 mm
Pochette de 4
Sachet de 20



51-830
59-880

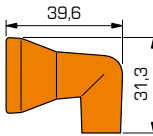

Assortiment de 4 Buses d'équerres

Pochette de 4 buses  51-832
Ø 6,35 - 9,5 - 12,7 - 8 trous Ø 4

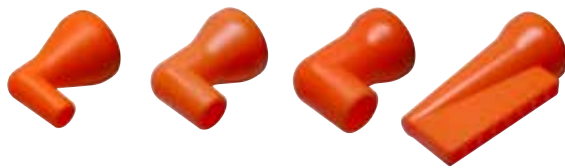

Buses plates

Buse plate

Réf. 

18 x 2 mm
Pochette de 4
Sachet de 20



51-840
59-890

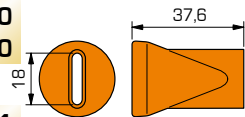

18 x 3,2 mm
Pochette de 4
Sachet de 20

51-841
59-891

Buse plate

Réf. 

31 x 4 mm
Pochette de 2
Sachet de 20



51-807
59-867

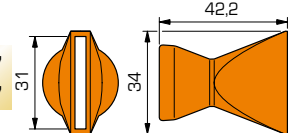

61 x 3 mm
Pochette de 2
Sachet de 20



51-809
59-871

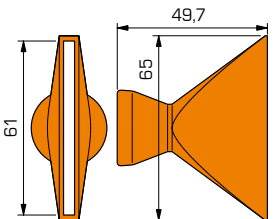

Buse à Jet Concentré

Réf. 

30 mm
Pochette de 2
Sachet de 20



51-847
59-897

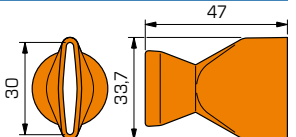

40 mm
Pochette de 2
Sachet de 20



51-848
59-898

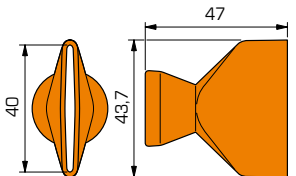

Buses multi-jets

Buse plate

Réf. 

7 trous Ø 2 mm
Pochette de 4
Sachet de 20



51-843
59-893

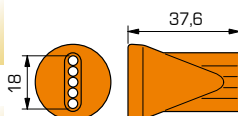

5 trous Ø 3,2
Pochette de 4
Sachet de 20

51-842
59-892

Buse orientable 63 mm

Réf. 

20 trous Ø 1,9 mm
L : 63 mm



51-845
59-895

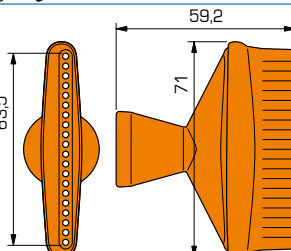

Pochette de 2
Sachet de 20

Buse d'équerre

Réf. 

8 trous Ø 4 mm
Pochette de 2
Sachet de 20



51-831
59-881

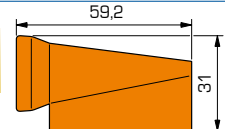

Assortiment de Buses

Assortiment de 16 Buses

Pochette

51-849

3 Buses rondes : Ø 6,35 - 9,5 - 12,7

3 Buses d'équerres : Ø 6,35 - 9,5 - 12,7

6 Buses plates : L 31 x 4 et 61 x 3

L 30 - 40 à jet concentré

L 18 x 2 et L 18 x 3,25

3 Buses multi-jets : 20 trous Ø 1,9

7 trous Ø 2 - 5 trous Ø 3,2

1 Buse d'équerre multi-jet : 8 trous Ø 4

Tuyaux Articulés 1/2" - Ø 12,7

Distributeurs et éléments de liaison

Élément de liaison

Dérivation en Y
1/2" vers 1/2"
Pochette de 2
Sachet de 20



Réf.  **51-808**
59-868

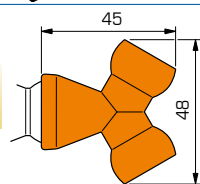

Manchon double femelle

Pochette de 4
Sachet de 20



Réf.  **51-811**
59-872

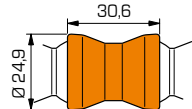

Adaptateur 1/2" vers 1/4"

Pochette de 2
Sachet de 20



Réf.  **51-821**
59-869

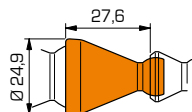

Adaptateur en Y

1/2" vers 1/4"
Pochette de 2
Sachet de 20



Réf.  **51-822**
59-870

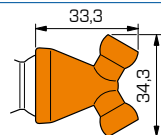

Élément de liaison

Coude mâle-femelle
1/2" vers 1/2"
Pochette de 2
Sachet de 20



Réf.  **51-824**
59-874

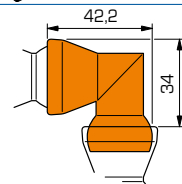

Dérivation en Té

1/2" vers 1/2"
Pochette de 2
Sachet de 20



Réf.  **51-825**
59-875

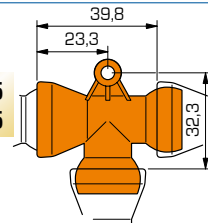

Support pour Manifold

Pochette de 2

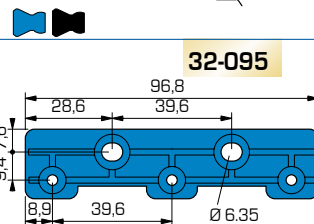

Distributeur standard

Manifold

1 support
3 dérivation en té
1 coude mâle-femelle



32-099

Distributeur complet

Manifold

1 support avec vis
3 dérivation en té
1 coude mâle-femelle
5 robinets en ligne



32-098

LOC-LINE noir disponible
sur commande 



Pincés d'assemblage

1 Pince 1/2" **78-002**
2 Pincés **78-003**
1 en 1/4" et 1 en 1/2"



Utilisez le plus souvent possible
pour assembler et déboîter le tuyau
en toute sécurité.

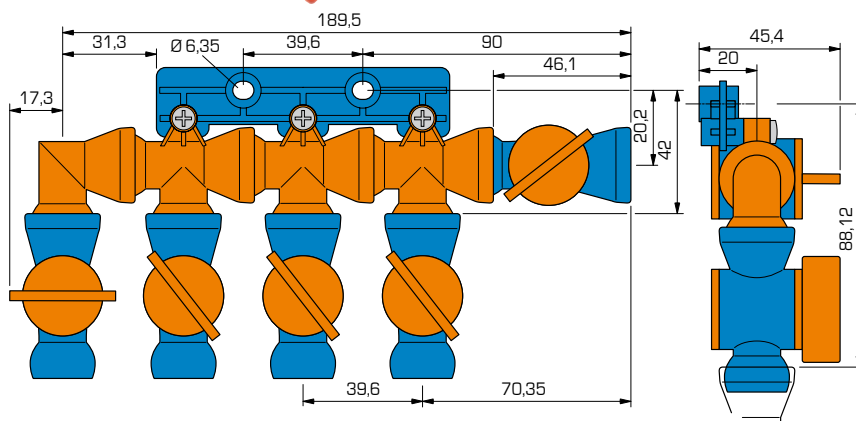

Rotule de fixation

Pochette de 2



51-895

Support d'écran de protection
de détecteur....

